

# MC79XX/MC79XXA/LM79XX

## 3-Terminal 1A Negative Voltage Regulator

### Features

- Output Current in Excess of 1A
- Output Voltages of -5, -6, -8,-9,-10, -12,-15,-18 and -24V
- Internal Thermal Overload Protection
- Short Circuit Protection
- Output Transistor Safe Operating Area Compensation

### Description

The MC79XX / MC79XXA / LM79XX series of three terminal negative regulators are available in TO-220 package and with several fixed output voltages, making them useful in a wide range of applications. Each type employs internal current limiting, thermal shut down and safe operating area protection, making it essentially indestructible.

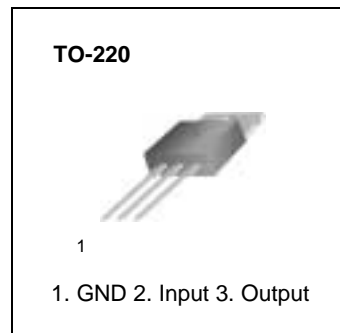

### Internal Block Diagram

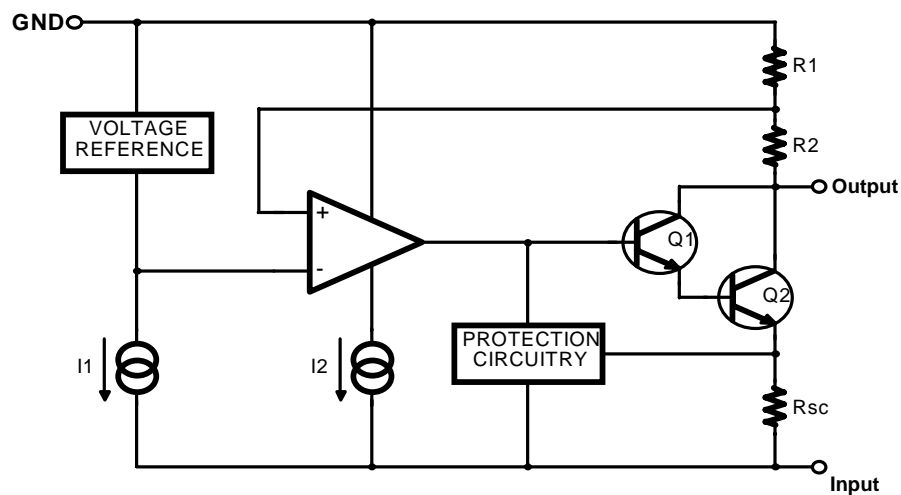

## Absolute Maximum Ratings

Parameter	Symbol	Value	Unit
Input Voltage	$V_I$	-35	V
Thermal Resistance Junction-Cases Junction-Air	$R_{\theta JC}$ $R_{\theta JA}$	5 65	$^{\circ}C/W$
Operating Temperature Range	$T_{OPR}$	0 ~ +125	$^{\circ}C$
Storage Temperature Range	$T_{STG}$	- 65 ~ +150	$^{\circ}C$

## Electrical Characteristics (MC7905/LM7905)

( $V_I = -10V$ ,  $I_O = 500mA$ ,  $0^{\circ}C \leq T_J \leq +125^{\circ}C$ ,  $C_I = 2.2\mu F$ ,  $C_O = 1\mu F$ , unless otherwise specified.)

Parameter	Symbol	Conditions	Min.	Typ.	Max.	Unit	
Output Voltage	$V_O$	$T_J = +25^{\circ}C$	- 4.8	- 5.0	- 5.2	V	
		$I_O = 5mA$ to 1A, $P_O \leq 15W$ $V_I = -7V$ to -20V	- 4.75	-5.0	- 5.25		
Line Regulation (Note1)	$\Delta V_O$	$T_J = +25^{\circ}C$	$V_I = -7V$ to -20V $I_O = 1A$	-	5	50	mV
			$V_I = -8V$ to -12V $I_O = 1A$	-	2	25	
		$V_I = -7.5V$ to -25V	-	7	50		
		$V_I = -8V$ to -12V $I_O = 1A$	-	7	50		
Load Regulation (Note1)	$\Delta V_O$	$T_J = +25^{\circ}C$ $I_O = 5mA$ to 1.5A	-	10	100	mV	
		$T_J = +25^{\circ}C$ $I_O = 250mA$ to 750mA	-	3	50		
Quiescent Current	$I_Q$	$T_J = +25^{\circ}C$	-	3	6	mA	
Quiescent Current Change	$\Delta I_Q$	$I_O = 5mA$ to 1A	-	0.05	0.5	mA	
		$V_I = -8V$ to -25V	-	0.1	0.8		
Temperature Coefficient of $V_D$	$\Delta V_O / \Delta T$	$I_O = 5mA$	-	- 0.4	-	mV/ $^{\circ}C$	
Output Noise Voltage	$V_N$	$f = 10Hz$ to 100KHz $T_A = +25^{\circ}C$	-	40	-	$\mu V$	
Ripple Rejection	RR	$f = 120Hz$ $\Delta V_I = 10V$	54	60	-	dB	
Dropout Voltage	$V_D$	$T_J = +25^{\circ}C$ $I_O = 1A$	-	2	-	V	
Short Circuit Current	$I_{SC}$	$T_J = +25^{\circ}C$ , $V_I = -35V$	-	300	-	mA	
Peak Current	$I_{PK}$	$T_J = +25^{\circ}C$	-	2.2	-	A	

### Note

1. Load and line regulation are specified at constant junction temperature. Changes in  $V_O$  due to heating effects must be taken into account separately. Pulse testing with low duty is used.

## Electrical Characteristics (MC7906)

( $V_I = -11V$ ,  $I_O = 500mA$ ,  $0^\circ C \leq T_J \leq +125^\circ C$ ,  $C_I = 2.2\mu F$ ,  $C_O = 1\mu F$ , unless otherwise specified.)

Parameter	Symbol	Conditions	Min.	Typ.	Max.	Unit	
Output Voltage	$V_O$	$T_J = +25^\circ C$	- 5.75	- 6	- 6.25	V	
		$I_O = 5mA$ to 1A, $P_O \leq 15W$ $V_I = - 9V$ to - 21V	- 5.7	- 6	- 6.3		
Line Regulation (Note1)	$\Delta V_O$	$T_J = +25^\circ C$	$V_I = - 8V$ to - 25V	-	10	120	mV
			$V_I = - 9V$ to -12V	-	5	60	
Load Regulation (Note1)	$\Delta V_O$	$T_J = +25^\circ C$ $I_O = 5mA$ to 1.5A	-	10	120	mV	
		$T_J = +25^\circ C$ $I_O = 250mA$ to 750mA	-	3	60		
Quiescent Current	$I_Q$	$T_J = +25^\circ C$	-	3	6	mA	
Quiescent Current Change	$\Delta I_Q$	$I_O = 5mA$ to 1A	-	-	0.5	mA	
		$V_I = -9V$ to -25V	-	-	1.3		
Temperature Coefficient of $V_D$	$\Delta V_O / \Delta T$	$I_O = 5mA$	-	-0.5	-	mV/ $^\circ C$	
Output Noise Voltage	$V_N$	$f = 10Hz$ to 100KHz $T_A = +25^\circ C$	-	130	-	$\mu V$	
Ripple Rejection	RR	$f = 120Hz$ $\Delta V_I = 10V$	54	60	-	dB	
Dropout Voltage	$V_D$	$T_J = +25^\circ C$ $I_O = 1A$	-	2	-	V	
Short Circuit Current	$I_{SC}$	$T_J = +25^\circ C$ , $V_I = -35V$	-	300	-	mA	
Peak Current	$I_{PK}$	$T_J = +25^\circ C$	-	2.2	-	A	

### Note

1. Load and line regulation are specified at constant junction temperature. Changes in  $V_O$  due to heating effects must be taken into account separately. Pulse testing with low duty is used.

## Electrical Characteristics (MC7908)

( $V_I = -14V$ ,  $I_O = 500mA$ ,  $0^\circ C \leq T_J \leq +125^\circ C$ ,  $C_I = 2.2\mu F$ ,  $C_O = 1\mu F$ , unless otherwise specified.)

Parameter	Symbol	Conditions	Min.	Typ.	Max.	Unit	
Output Voltage	$V_O$	$T_J = +25^\circ C$	- 7.7	- 8	- 8.3	V	
		$I_O = 5mA$ to 1A, $P_O \leq 15W$ $V_I = -10V$ to -23V	- 7.6	- 8	- 8.4		
Line Regulation (Note1)	$\Delta V_O$	$T_J = +25^\circ C$	$V_I = -10.5V$ to -25V	-	10	100	mV
			$V_I = -11V$ to -17V	-	5	80	
Load Regulation (Note1)	$\Delta V_O$	$T_J = +25^\circ C$ $I_O = 5mA$ to 1.5A	-	12	160	mV	
		$T_J = +25^\circ C$ $I_O = 250mA$ to 750mA	-	4	80		
Quiescent Current	$I_Q$	$T_J = +25^\circ C$	-	3	6	mA	
Quiescent Current Change	$\Delta I_Q$	$I_O = 5mA$ to 1A	-	0.05	0.5	mA	
		$V_I = -11.5V$ to -25V	-	0.1	1		
Temperature Coefficient of $V_D$	$\Delta V_O / \Delta T$	$I_O = 5mA$	-	-0.6	-	mV/ $^\circ C$	
Output Noise Voltage	$V_N$	$f = 10Hz$ to 100KHz $T_A = +25^\circ C$	-	175	-	$\mu V$	
Ripple Rejection	RR	$f = 120Hz$ $\Delta V_I = 10V$	54	60	-	dB	
Dropout Voltage	$V_D$	$T_J = +25^\circ C$ $I_O = 1A$	-	2	-	V	
Short Circuit Current	$I_{SC}$	$T_J = +25^\circ C$ , $V_I = -35V$	-	300	-	mA	
Peak Current	$I_{PK}$	$T_J = +25^\circ C$	-	2.2	-	A	

### Note

1. Load and line regulation are specified at constant junction temperature. Changes in  $V_O$  due to heating effects must be taken into account separately. Pulse testing with low duty is used.

## Electrical Characteristics (MC7909)

( $V_I = -14V$ ,  $I_O = 500mA$ ,  $0^\circ C \leq T_J \leq +125^\circ C$ ,  $C_I = 2.2\mu F$ ,  $C_O = 1\mu F$ , unless otherwise specified.)

Parameter	Symbol	Conditions	Min.	Typ.	Max.	Unit	
Output Voltage	$V_O$	$T_J = +25^\circ C$	- 8.7	- 9.0	- 9.3	V	
		$I_O = 5mA$ to 1A, $P_O \leq 15W$ $V_I = -1.5V$ to -23V	- 8.6	- 9.0	- 9.4		
Line Regulation (Note1)	$\Delta V_O$	$T_J = +25^\circ C$	$V_I = -10.5V$ to -25V	-	10	180	mV
			$V_I = -11V$ to -17V	-	5	90	
Load Regulation (Note1)	$\Delta V_O$	$T_J = +25^\circ C$ $I_O = 5mA$ to 1.5A	-	12	180	mV	
		$T_J = +25^\circ C$ $I_O = 250mA$ to 750mA	-	4	90		
Quiescent Current	$I_Q$	$T_J = +25^\circ C$	-	3	6	mA	
Quiescent Current Change	$\Delta I_Q$	$I_O = 5mA$ to 1A	-	0.05	0.5	mA	
		$V_I = -11.5V$ to -25V	-	0.1	1		
Temperature Coefficient of $V_D$	$\Delta V_O / \Delta T$	$I_O = 5mA$	-	-0.6	-	mV/ $^\circ C$	
Output Noise Voltage	$V_N$	$f = 10Hz$ to 100KHz $T_A = +25^\circ C$	-	175	-	$\mu V$	
Ripple Rejection	RR	$f = 120Hz$ $\Delta V_I = 10V$	54	60	-	dB	
Dropout Voltage	$V_D$	$T_J = +25^\circ C$ $I_O = 1A$	-	2	-	V	
Short Circuit Current	$I_{SC}$	$T_J = +25^\circ C$ , $V_I = -35V$	-	300	-	mA	
Peak Current	$I_{PK}$	$T_J = +25^\circ C$	-	2.2	-	A	

### Note

1. Load and line regulation are specified at constant junction temperature. Changes in  $V_O$  due to heating effects must be taken into account separately. Pulse testing with low duty is used.

## Electrical Characteristics (MC7910)

( $V_I = -17V$ ,  $I_O = 500mA$ ,  $0^\circ C \leq T_J \leq +125^\circ C$ ,  $C_I = 2.2\mu F$ ,  $C_O = 1\mu F$ , unless otherwise specified.)

Parameter	Symbol	Conditions	Min.	Typ.	Max.	Unit	
Output Voltage	$V_O$	$T_J = +25^\circ C$	- 10.5	- 10	- 11.5	V	
		$I_O = 5mA$ to 1A, $P_d \leq 15W$ $V_I = -12V$ to -28	- 10.4	- 10	- 11.6		
Line Regulation (Note1)	$\Delta V_O$	$T_J = +25^\circ C$	$V_I = -12.5V$ to -28V	-	12	200	mV
			$V_I = -14V$ to -20V	-	6	100	
Load Regulation (Note1)	$\Delta V_O$	$T_J = +25^\circ C$ $I_O = 5mA$ to 1.5A	-	12	200	mV	
		$T_J = +25^\circ C$ $I_O = 250mA$ to 750mA	-	4	100		
Quiescent Current	$I_Q$	$T_J = +25^\circ C$	-	3	6	mA	
Quiescent Current Change	$\Delta I_Q$	$I_O = 5mA$ to 1A	-	0.05	0.5	mA	
		$V_I = -13V$ to -28V	-	0.1	1		
Temperature Coefficient of $V_O$	$\Delta V_O / \Delta T$	$I_O = 5mA$	-	-1	-	mV/ $^\circ C$	
Output Noise Voltage	$V_N$	$10Hz \leq f \leq 100KHz$ $T_A = +25^\circ C$	-	280	-	$\mu V$	
Ripple Rejection	RR	$f = 120Hz$ $\Delta V_I = 10V$	54	60	-	dB	
Dropout Voltage	$V_D$	$T_J = +25^\circ C$ $I_O = 1A$	-	2	-	V	
Short Circuit Current	$I_{SC}$	$T_J = +25^\circ C$ , $V_I = -35V$	-	300	-	mA	
Peak Current	$I_{PK}$	$T_J = +25^\circ C$	-	2.2	-	A	

### Note

1. Load and line regulation are specified at constant junction temperature. Changes in  $V_O$  due to heating effects must be taken into account separately. Pulse testing with low duty is used.

## Electrical Characteristics (MC7912)

( $V_I = -18V$ ,  $I_O = 500mA$ ,  $0^\circ C \leq T_J \leq +125^\circ C$ ,  $C_I = 2.2\mu F$ ,  $C_O = 1\mu F$ , unless otherwise specified.)

Parameter	Symbol	Conditions	Min.	Typ.	Max.	Unit	
Output Voltage	$V_O$	$T_J = +25^\circ C$	-11.5	-12	-12.5	V	
		$I_O = 5mA$ to $1A$ , $P_O \leq 15W$ $V_I = -15.5V$ to $-27V$	-11.4	-12	-12.6		
Line Regulation (Note1)	$\Delta V_O$	$T_J = +25^\circ C$	$V_I = -14.5V$ to $-30V$	-	12	240	mV
			$V_I = -16V$ to $-22V$	-	6	120	
Load Regulation (Note1)	$\Delta V_O$	$T_J = +25^\circ C$ $I_O = 5mA$ to $1.5A$	-	12	240	mV	
		$T_J = +25^\circ C$ $I_O = 250mA$ to $750mA$	-	4	120		
Quiescent Current	$I_Q$	$T_J = +25^\circ C$	-	3	6	mA	
Quiescent Current Change	$\Delta I_Q$	$I_O = 5mA$ to $1A$	-	0.05	0.5	mA	
		$V_I = -15V$ to $-30V$	-	0.1	1		
Temperature Coefficient of $V_D$	$\Delta V_O / \Delta T$	$I_O = 5mA$	-	-0.8	-	mV/ $^\circ C$	
Output Noise Voltage	$V_N$	$f = 10Hz$ to $100KHz$ $T_A = +25^\circ C$	-	200	-	$\mu V$	
Ripple Rejection	RR	$f = 120Hz$ $\Delta V_I = 10V$	54	60	-	dB	
Dropout Voltage	$V_D$	$T_J = +25^\circ C$ $I_O = 1A$	-	2	-	V	
Short Circuit Current	ISC	$T_J = +25^\circ C$ , $V_I = -35V$	-	300	-	mA	
Peak Current	IPK	$T_J = +25^\circ C$	-	2.2	-	A	

### Note

1. Load and line regulation are specified at constant junction temperature. Changes in  $V_O$  due to heating effects must be taken into account separately. Pulse testing with low duty is used.

## Electrical Characteristics (MC7915)

( $V_I = -23V$ ,  $I_O = 500mA$ ,  $0^\circ C \leq T_J \leq +125^\circ C$ ,  $C_I = 2.2\mu F$ ,  $C_O = 1\mu F$ , unless otherwise specified.)

Parameter	Symbol	Conditions	Min.	Typ.	Max.	Unit	
Output Voltage	$V_O$	$T_J = +25^\circ C$	-14.4	-15	-15.6	V	
		$I_O = 5mA$ to 1A, $P_O \leq 15W$ $V_I = -18V$ to -30V	-14.25	-15	-15.75		
Line Regulation (Note1)	$\Delta V_O$	$T_J = +25^\circ C$	$V_I = -17.5V$ to -30V	-	12	300	mV
			$V_I = -20V$ to -26V	-	6	150	
Load Regulation (Note1)	$\Delta V_O$	$T_J = +25^\circ C$ $I_O = 5mA$ to 1.5A	-	12	300	mV	
		$T_J = +25^\circ C$ $I_O = 250mA$ to 750mA	-	4	150		
Quiescent Current	$I_Q$	$T_J = +25^\circ C$	-	3	6	mA	
Quiescent Current Change	$\Delta I_Q$	$I_O = 5mA$ to 1A	-	0.05	0.5	mA	
		$V_I = -18.5V$ to -30V	-	0.1	1		
Temperature Coefficient of $V_D$	$\Delta V_O / \Delta T$	$I_O = 5mA$	-	-0.9	-	mV/ $^\circ C$	
Output Noise Voltage	$V_N$	$f = 10Hz$ to 100KHz $T_A = +25^\circ C$	-	250	-	$\mu V$	
Ripple Rejection	RR	$f = 120Hz$ $\Delta V_I = 10V$	54	60	-	dB	
Dropout Voltage	$V_D$	$T_J = +25^\circ C$ $I_O = 1A$	-	2	-	V	
Short Circuit Current	ISC	$T_J = +25^\circ C$ , $V_I = -35V$	-	300	-	mA	
Peak Current	IPK	$T_J = +25^\circ C$	-	2.2	-	A	

### Note

1. Load and line regulation are specified at constant junction temperature. Changes in  $V_O$  due to heating effects must be taken into account separately. Pulse testing with low duty is used.



## Electrical Characteristics (MC7918)

( $V_I = -27V$ ,  $I_O = 500mA$ ,  $0^\circ C \leq T_J \leq +125^\circ C$ ,  $C_I = 2.2\mu F$ ,  $C_O = 1\mu F$ , unless otherwise specified.)

Parameter	Symbol	Conditions	Min.	Typ.	Max.	Unit	
Output Voltage	$V_O$	$T_J = +25^\circ C$	-17.3	-18	-18.7	V	
		$I_O = 5mA$ to $1A$ , $P_O \leq 15W$ $V_I = -22.5V$ to $-33V$	-17.1	-18	-18.9		
Line Regulation (Note1)	$\Delta V_O$	$T_J = +25^\circ C$	$V_I = -21V$ to $-33V$	-	15	360	mV
			$V_I = -24V$ to $-30V$	-	8	180	
Load Regulation (Note1)	$\Delta V_O$	$T_J = +25^\circ C$ $I_O = 5mA$ to $1.5A$	-	15	360	mV	
		$T_J = +25^\circ C$ $I_O = 250mA$ to $750mA$	-	5	180		
Quiescent Current	$I_Q$	$T_J = +25^\circ C$	-	3	6	mA	
Quiescent Current Change	$\Delta I_Q$	$I_O = 5mA$ to $1A$	-	-	0.5	mA	
		$V_I = -22V$ to $-33V$	-	-	1		
Temperature Coefficient of $V_D$	$\Delta V_O / \Delta T$	$I_O = 5mA$	-	-1	-	mV/ $^\circ C$	
Output Noise Voltage	$V_N$	$f = 10Hz$ to $100KHz$ $T_A = +25^\circ C$	-	300	-	$\mu V$	
Ripple Rejection	RR	$f = 120Hz$ $\Delta V_I = 10V$	54	60	-	dB	
Dropout Voltage	$V_D$	$T_J = +25^\circ C$ $I_O = 1A$	-	2	-	V	
Short Circuit Current	$I_{SC}$	$T_J = +25^\circ C$ , $V_I = -35V$	-	300	-	mA	
Peak Current	$I_{PK}$	$T_J = +25^\circ C$	-	2.2	-	A	

### Note

1. Load and line regulation are specified at constant junction temperature. Changes in  $V_O$  due to heating effects must be taken into account separately. Pulse testing with low duty is used.

## Electrical Characteristics (MC7924)

( $V_I = -33V$ ,  $I_O = 500mA$ ,  $0^\circ C \leq T_J \leq +125^\circ C$ ,  $C_I = 2.2\mu F$ ,  $C_O = 1\mu F$ , unless otherwise specified.)

Parameter	Symbol	Conditions	Min.	Typ.	Max.	Unit	
Output Voltage	$V_O$	$T_J = +25^\circ C$	- 23	- 24	- 25	V	
		$I_O = 5mA$ to 1A, $P_O \leq 15W$ $V_I = -27V$ to -38V	- 22.8	- 24	- 25.2		
Line Regulation (Note1)	$\Delta V_O$	$T_J = +25^\circ C$	$V_I = -27V$ to -38V	-	15	480	mV
			$V_I = -30V$ to -36V	-	8	180	
Load Regulation (Note1)	$\Delta V_O$	$T_J = +25^\circ C$ $I_O = 5mA$ to 1.5A	-	15	480	mV	
		$T_J = +25^\circ C$ $I_O = 250mA$ to 750mA	-	5	240		
Quiescent Current	$I_Q$	$T_J = +25^\circ C$	-	3	6	mA	
Quiescent Current Change	$\Delta I_Q$	$I_O = 5mA$ to 1A	-	-	0.5	mA	
		$V_I = -27V$ to -38V	-	-	1		
Temperature Coefficient of $V_D$	$\Delta V_O / \Delta T$	$I_O = 5mA$	-	-1	-	mV/ $^\circ C$	
Output Noise Voltage	$V_N$	$f = 10Hz$ to 100KHz $T_A = +25^\circ C$	-	400	-	$\mu V$	
Ripple Rejection	RR	$f = 120Hz$ $\Delta V_I = 10V$	54	60	-	dB	
Dropout Voltage	$V_D$	$T_J = +25^\circ C$ $I_O = 1A$	-	2	-	V	
Short Circuit Current	ISC	$T_J = +25^\circ C$ , $V_I = -35V$	-	300	-	mA	
Peak Current	$I_{PK}$	$T_J = +25^\circ C$	-	2.2	-	A	

### Note

1. Load and line regulation are specified at constant junction temperature. Changes in  $V_O$  due to heating effects must be taken into account separately. Pulse testing with low duty is used.

## Electrical Characteristics (MC7905A)

( $V_I = -10V$ ,  $I_O = 500mA$ ,  $0^\circ C \leq T_J \leq +125^\circ C$ ,  $C_I = 2.2\mu F$ ,  $C_O = 1\mu F$ , unless otherwise specified.)

Parameter	Symbol	Conditions	Min.	Typ.	Max.	Unit	
Output Voltage	$V_O$	$T_J = +25^\circ C$	- 4.9	- 5.0	- 5.1	V	
		$I_O = 5mA$ to 1A, $P_O \leq 15W$ $V_I = -7V$ to -20V	- 4.8	-5.0	- 5.2		
Line Regulation (Note1)	$\Delta V_O$	$T_J = +25^\circ C$	$V_I = -7V$ to -20V $I_O = 1A$	-	5	50	mV
			$V_I = -8V$ to -12V $I_O = 1A$	-	2	25	
		$T_J = +25^\circ C$ , $V_I = -7.5V$ to -25V		-	7	50	
		$V_I = -8V$ to -12V, $I_O = 1A$		-	7	50	
Load Regulation (Note1)	$\Delta V_O$	$I_O = 5mA$ to 1.5A	-	10	100	mV	
		$T_J = +25^\circ C$ $I_O = 250mA$ to 750mA	-	3	50		
Quiescent Current	$I_Q$	$T_J = +25^\circ C$	-	3	6	mA	
Quiescent Current Change	$\Delta I_Q$	$I_O = 5mA$ to 1A	-	0.05	0.5	mA	
		$V_I = -8V$ to -25V	-	0.1	0.8		
Temperature Coefficient of $V_D$	$\Delta V_O / \Delta T$	$I_O = 5mA$	-	- 0.4	-	mV/ $^\circ C$	
Output Noise Voltage	$V_N$	$f = 10Hz$ to 100KHz $T_A = +25^\circ C$	-	40	-	$\mu V$	
Ripple Rejection	RR	$f = 120Hz$ $\Delta V_I = 10V$	54	60	-	dB	
Dropout Voltage	$V_D$	$T_J = +25^\circ C$ $I_O = 1A$	-	2	-	V	
Short Circuit Current	ISC	$T_J = +25^\circ C$ , $V_I = -35V$	-	300	-	mA	
Peak Current	IPK	$T_J = +25^\circ C$	-	2.2	-	A	

### Note

1. Load and line regulation are specified at constant junction temperature. Changes in  $V_O$  due to heating effects must be taken into account separately. Pulse testing with low duty is used.

## Electrical Characteristics (MC7912A)

( $V_I = -18V$ ,  $I_O = 500mA$ ,  $0^\circ C \leq T_J \leq +125^\circ C$ ,  $C_I = 2.2\mu F$ ,  $C_O = 1\mu F$ , unless otherwise specified.)

Parameter	Symbol	Conditions	Min.	Typ.	Max.	Unit	
Output Voltage	$V_O$	$T_J = +25^\circ C$	-11.75	-12	-12.25	V	
		$I_O = 5mA$ to 1A, $P_O \leq 15W$ $V_I = -15.5V$ to -27V	-11.5	-12	-12.5		
Line Regulation (Note1)	$\Delta V_O$	$T_J = +25^\circ C$	$V_I = -14.5V$ to -30V	-	12	240	mV
			$V_I = -16V$ to -22V	-	6	120	
Load Regulation (Note1)	$\Delta V_O$	$T_J = +25^\circ C$ $I_O = 5mA$ to 1.5A	-	12	240	mV	
		$T_J = +25^\circ C$ $I_O = 250mA$ to 750mA	-	4	120		
Quiescent Current	$I_Q$	$T_J = +25^\circ C$	-	3	6	mA	
Quiescent Current Change	$\Delta I_Q$	$I_O = 5mA$ to 1A	-	0.05	0.5	mA	
		$V_I = -15V$ to -30V	-	0.1	1		
Temperature Coefficient of $V_D$	$\Delta V_O / \Delta T$	$I_O = 5mA$	-	-0.8	-	mV/ $^\circ C$	
Output Noise Voltage	$V_N$	$f = 10Hz$ to 100KHz $T_A = +25^\circ C$	-	200	-	$\mu V$	
Ripple Rejection	RR	$f = 120Hz$ $\Delta V_I = 10V$	54	60	-	dB	
Dropout Voltage	$V_D$	$T_J = +25^\circ C$ $I_O = 1A$	-	2	-	V	
Short Circuit Current	ISC	$T_J = +25^\circ C$ , $V_I = -35V$	-	300	-	mA	
Peak Current	IPK	$T_J = +25^\circ C$	-	2.2	-	A	

### Note

1. Load and line regulation are specified at constant junction temperature. Changes in  $V_O$  due to heating effects must be taken into account separately. Pulse testing with low duty is used.

## Electrical Characteristics (MC7915A)

( $V_I = -18V$ ,  $I_O = 500mA$ ,  $0^\circ C \leq T_J \leq +125^\circ C$ ,  $C_I = 2.2\mu F$ ,  $C_O = 1\mu F$ , unless otherwise specified.)

Parameter	Symbol	Conditions	Min.	Typ.	Max.	Unit	
Output Voltage	$V_O$	$T_J = +25^\circ C$	-14.7	-15	-15.3	V	
		$I_O = 5mA$ to $1A$ , $P_O \leq 15W$ $V_I = -18V$ to $-30V$	-14.4	-15	-15.6		
Line Regulation (Note1)	$\Delta V_O$	$T_J = +25^\circ C$	$V_I = -17.5V$ to $-30V$	-	12	300	mV
			$V_I = -20V$ to $-26V$	-	6	150	
Load Regulation (Note1)	$\Delta V_O$	$T_J = +25^\circ C$ $I_O = 5mA$ to $1.5A$	-	12	300	mV	
		$T_J = +25^\circ C$ $I_O = 250mA$ to $750mA$	-	4	150		
Quiescent Current	$I_Q$	$T_J = +25^\circ C$	-	3	6	mA	
Quiescent Current Change	$\Delta I_Q$	$I_O = 5mA$ to $1A$	-	0.05	0.5	mA	
		$V_I = -18.5V$ to $-30V$	-	0.1	1		
Temperature Coefficient of $V_D$	$\Delta V_O / \Delta T$	$I_O = 5mA$	-	-0.9	-	mV/ $^\circ C$	
Output Noise Voltage	$V_N$	$f = 10Hz$ to $100KHz$ $T_A = +25^\circ C$	-	250	-	$\mu V$	
Ripple Rejection	RR	$f = 120Hz$ $\Delta V_I = 10V$	54	60	-	dB	
Dropout Voltage	$V_D$	$T_J = +25^\circ C$ $I_O = 1A$	-	2	-	V	
Short Circuit Current	$I_{SC}$	$T_J = +25^\circ C$ , $V_I = -35V$	-	300	-	mA	
Peak Current	$I_{PK}$	$T_J = +25^\circ C$	-	2.2	-	A	

### Note

1. Load and line regulation are specified at constant junction temperature. Changes in  $V_O$  due to heating effects must be taken into account separately. Pulse testing with low duty is used.

# Typical Performance Characteristics

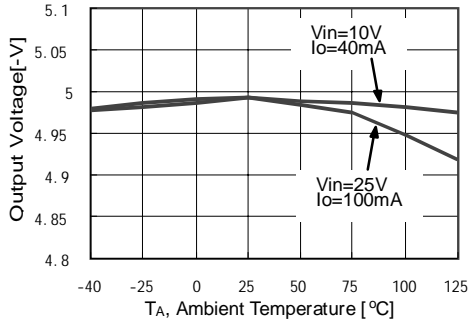

Figure 1. Output Voltage

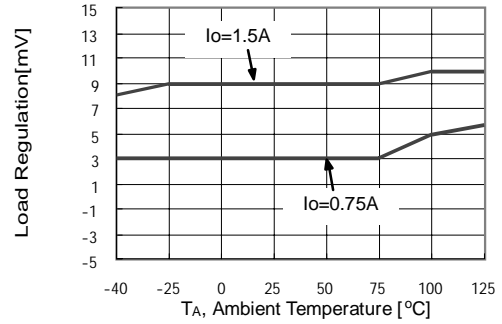

Figure 2. Load Regulation

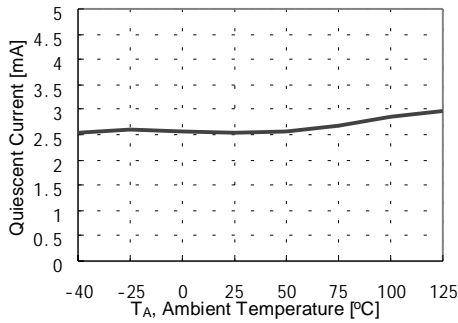

Figure 3. Quiescent Current

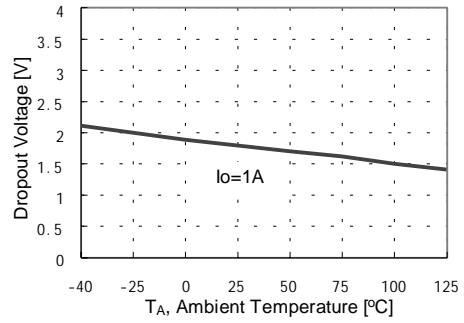

Figure 4. Dropout Voltage



Figure 5. Short Circuit Current

## Typical Applications

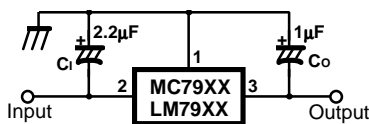

Figure 6. Negative Fixed output regulator

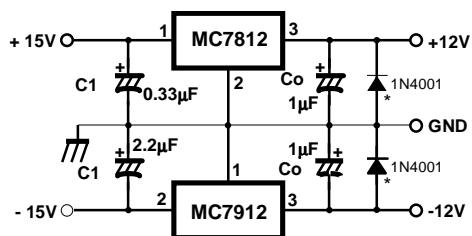

Figure 7. Split power supply ( ± 12V/1A)

### Notes:

- (1) To specify an output voltage, substitute voltage value for "XX "
- (2) Required for stability. For value given, capacitor must be solid tantalum. If aluminium electronics are used, at least ten times value shown should be selected. C<sub>1</sub> is required if regulator is located an appreciable distance from power supply filter.
- (3) To improve transient response. If large capacitors are used, a high current diode from input to output (1N4001 or similar) should be introduced to protect the device from momentary input short circuit.

# Mechanical Dimensions

## Package

### TO-220

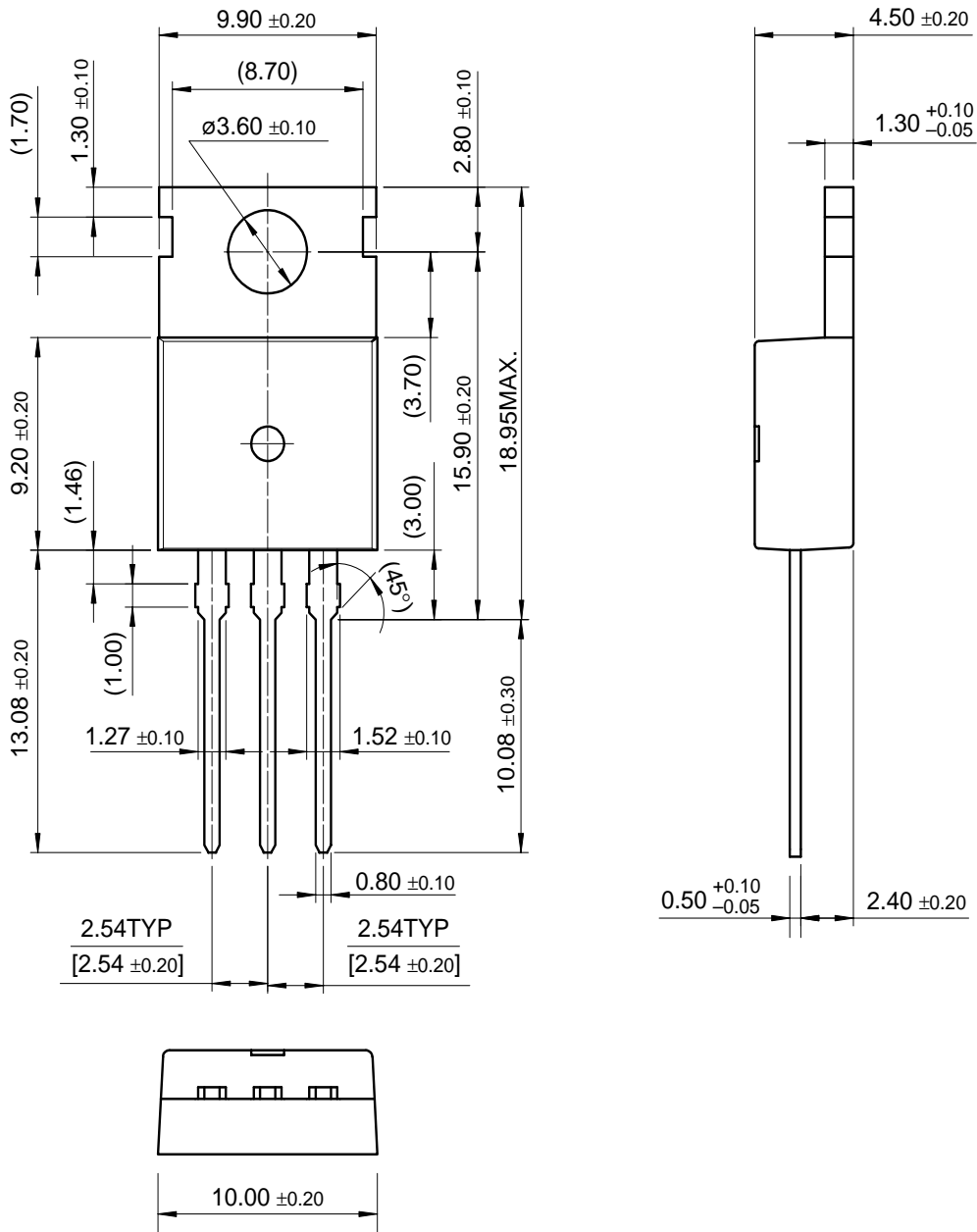



## Ordering Information

Product Number	Output Voltage Tolerance	Package	Operating Temperature
LM7905CT	±4%	TO-220	0 ~ + 125°C

Product Number	Output Voltage Tolerance	Package	Operating Temperature
MC7905CT	±4%	TO-220	0 ~ + 125°C
MC7906CT			
MC7908CT			
MC7909CT			
MC7910CT			
MC7912CT			
MC7915CT			
MC7918CT			
MC7924CT			
MC7905ACT	±2%		
MC7912ACT			
MC7915ACT			

**DISCLAIMER**

FAIRCHILD SEMICONDUCTOR RESERVES THE RIGHT TO MAKE CHANGES WITHOUT FURTHER NOTICE TO ANY PRODUCTS HEREIN TO IMPROVE RELIABILITY, FUNCTION OR DESIGN. FAIRCHILD DOES NOT ASSUME ANY LIABILITY ARISING OUT OF THE APPLICATION OR USE OF ANY PRODUCT OR CIRCUIT DESCRIBED HEREIN; NEITHER DOES IT CONVEY ANY LICENSE UNDER ITS PATENT RIGHTS, NOR THE RIGHTS OF OTHERS.

**LIFE SUPPORT POLICY**

FAIRCHILD'S PRODUCTS ARE NOT AUTHORIZED FOR USE AS CRITICAL COMPONENTS IN LIFE SUPPORT DEVICES OR SYSTEMS WITHOUT THE EXPRESS WRITTEN APPROVAL OF THE PRESIDENT OF FAIRCHILD SEMICONDUCTOR CORPORATION. As used herein:

1. Life support devices or systems are devices or systems which, (a) are intended for surgical implant into the body, or (b) support or sustain life, and (c) whose failure to perform when properly used in accordance with instructions for use provided in the labeling, can be reasonably expected to result in a significant injury of the user.
2. A critical component in any component of a life support device or system whose failure to perform can be reasonably expected to cause the failure of the life support device or system, or to affect its safety or effectiveness.

This datasheet has been download from:

[www.datasheetcatalog.com](http://www.datasheetcatalog.com)

Datasheets for electronics components.